

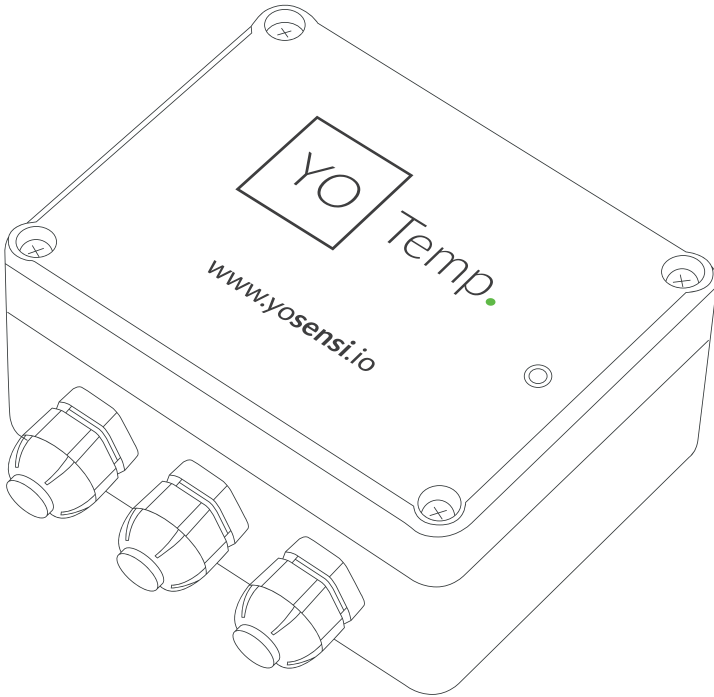

**Temp.**  
Datasheet





## Application

- YO Temp is a LoRaWAN device for measuring temperature at three external points.
- Additionally, the device contains sensors that measure temperature, relative humidity and an optional accelerometer (it sends information about its own position on the x, y, z axes).

## Components

- The device consists of a microcontroller, communication modules (LoRa, Bluetooth Low Energy), sensors and batteries.
- YO Temp is equipped with an enclosure made of ABS with IP67 protection class.
- The enclosure of the device has IP68 buffers for which measurement probes can be installed.
- No temperature probes are attached to the device. Our offer includes temperature sensors designed for outdoor use with various wire lengths (1 m, 2 m, 3 m, 5 m, 10 m, 15 m, 20 m).
- The enclosure is designed to be easily mounted on the wall.
- YO Temp is equipped with a diode that indicates the operating status.

# Operation of the device

- A LoRaWAN network is required for data transmission.
- The device requires no external power supply.
- Place the device at the location for temperature measurement and configure/reconfigure the device via BLE.
- The device takes measurements at the interval specified in the configuration parameters.
- Yosensi can provide access to a mobile application as a part of a comprehensive solution, allowing the device to be configured and connected to the LoRaWAN network. Additionally, it offers a preview of the operating parameters via BLE or NFC, depending on the version of the device.
- It is recommended that the device be added to the Yosensi Suite system, which allows for the easy management of the data transmitted by the devices.

## Device configuration

### Device settings

Measuring interval (of external temperature)

### Bluetooth Low Energy (BLE) settings

Transmission power  
Advertising frame interval

### LoRaWAN settings

Operating mode selection (OTAA or ABP)

#### OTAA

- Device EUI
- Application EUI
- Application key
- Number of trials

#### ABP

- Device address
- Network session key
- Application session key

## Advantages

- Production quality – made in the European Union by qualified engineers.
- YO Temp is a wireless device that uses LoRaWAN technology.
- The device works based on the radio, so there is no need for additional wires.
- As a complementary solution, Yosensi offers the purchase of external temperature sensors. These sensors have a silicone wire and a metal sensor enclosure, which makes them resistant to oil, alcohol and some solvents. They are also designed to work in higher temperatures.
- Very low power consumption.
- Depending on the version, the LoRa radio can operate in different regions (e.g., EU868, US915, AU915 etc.) adapted to different ISM frequency bands.
- Using Bluetooth Low Energy (BLE) provides:
  - Configuration convenience
  - Live preview of the data collected
  - Possibility of firmware update via OTA
  - Very low energy consumption
  - Wide range
- Supported LoRaWAN connection over ABP or OTAA.
- Mobile application for convenient device configuration and network monitoring.
- Access to the Yosensi Suite system for configuring devices and managing infrastructure.

# Technical details

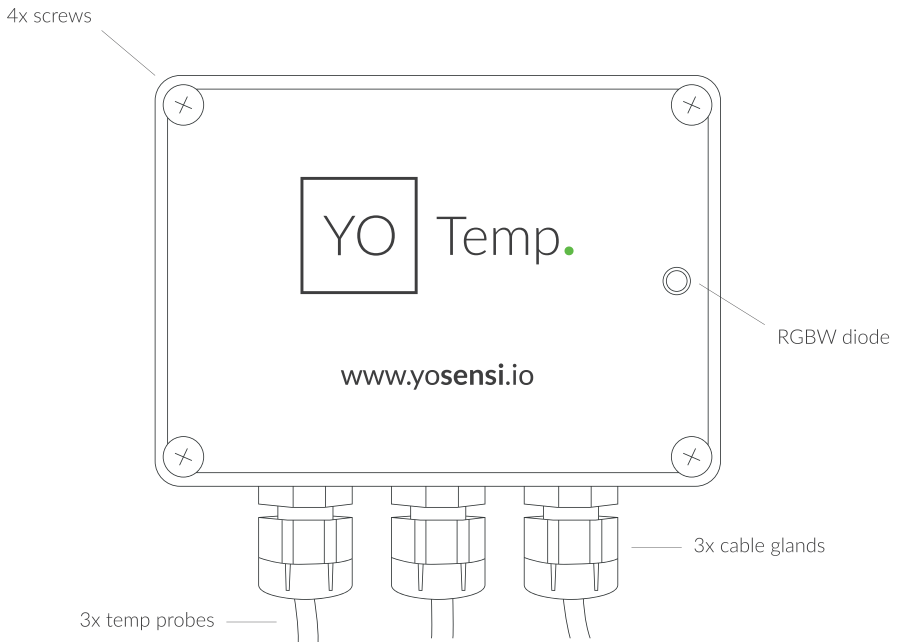

Figure 1. Top view of the device.

# Enclosure of the device

<b>Dimensions</b>	Height: 42 mm Depth: 64 mm	Width: 88 mm
<b>Colour</b>	Light grey	
<b>Installation</b> Choose from	Horizontal Vertical (can be screwed to the wall)	
<b>Enclosure material</b>	ABS	
<b>Level of protection</b>	IP67	

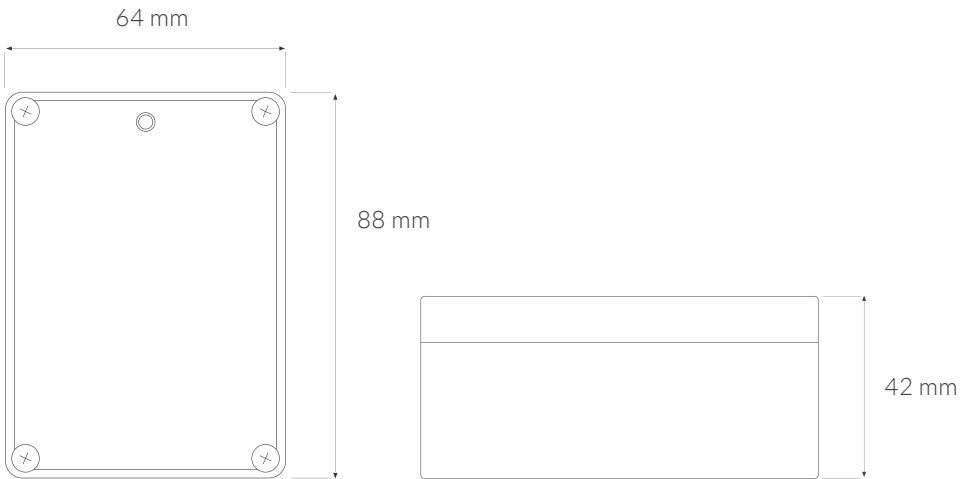

Figure 2. Dimensions of the device.

# Parameters

## Tx Power

LoRa EU868: to +14 [dBm]  
LoRa US915, AU915, AS923: to +22 [dBm]  
Bluetooth Low Energy (BLE): -20 to +6 [dBm]

## Power supply

3 × AA battery

## Measuring range

### External temperature (external temperature sensor):

Measurement range: from -55°C to 125°C (-67°F to 257°F)  
Accuracy:  $\pm 0.5^\circ\text{C}$  (32.9°F) (in temperatures from -10°C to 85°C (14°F to 185°F))

### Temperature:

Measurement range: from -40°C to 125°C (-40°F to 257°F)  
Accuracy:  $\pm 0.2^\circ\text{C}$  (in temperatures from 5°C to 60°C (41°F to 140°F))

### Relative humidity:

Measurement range: from 0% to 100%  
Accuracy:  $\pm 2\%$  (relative humidity from 20% to 80%)

### Accelerometer:

Measurement range:  $\pm 180^\circ$  on the x, y, and z axes  
Accuracy:  $\pm 0.1^\circ$  (in temperatures from -40°C to 85°C (-40°F to 185°F))

## Weight

Without batteries: 134 g  
With batteries: 204 g

# Sample charts

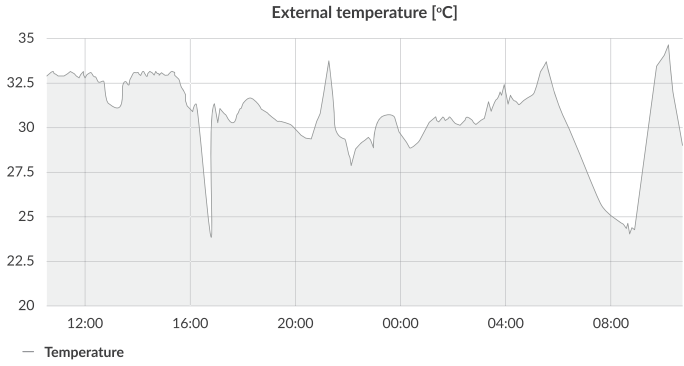

Example of an **external temperature** measurement chart for channel one.

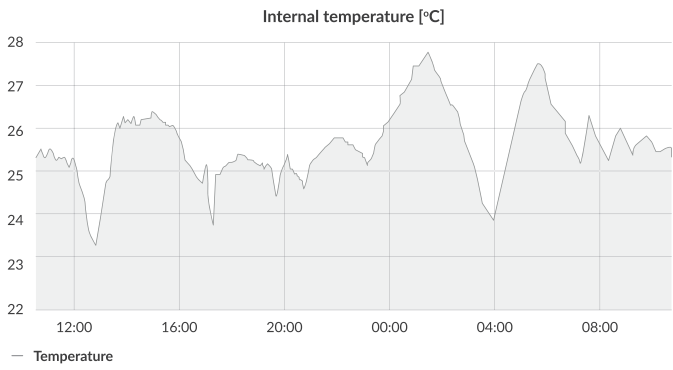

Example of an **internal temperature** measurement chart.

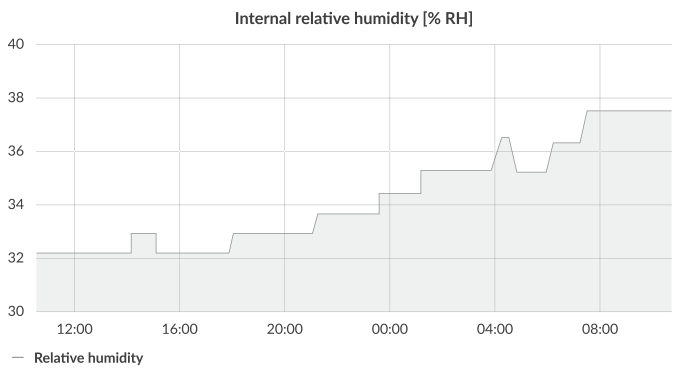

Example of an **internal relative humidity** measurement chart.







The logo for YOSSENSI.IO is enclosed in a thin black rectangular border. The text 'YOSENSI' is in a bold, uppercase, sans-serif font, followed by '.IO' in a smaller, regular weight of the same font. A small green dot is positioned above the 'I' in '.IO'.

YOSENSI.IO

The LoRa Alliance Member logo features the LoRa logo (a stylized 'L' with three curved lines above it) followed by the text 'LoRa Alliance Member' in a sans-serif font.

LoRa Alliance Member

## Contact us

-  [www.yosensi.io](http://www.yosensi.io)
-  [contact@yosensi.io](mailto:contact@yosensi.io)
-  +48 884 980 357
-  Zurawia 71A, Bialystok, Poland

